

**AIR CONDITIONER**  
**REMOTE CONTROLLER ILLUSTRATION**



The design and specifications are subject to change without prior notice for product improvement. Consult with the sales agency or manufacturer for details.

CR168-RG51FEU1

Thank you very much for purchasing our air conditioner. Please read this owner's manual carefully before using your air conditioner. Make sure to save this manual for future reference.

# CONTENTS

Remote controller Specifications.....	2
Operation of buttons .....	3
Indicators on LCD .....	6
How to use the buttons .....	7
Auto operation.....	7
Cooling/Heating/Fan operation.....	7
Dehumidifying operation .....	8
Timer operation.....	9
Handling the remote controller .....	12

## Remote Controller Specifications

Model	RG51F/EU1, RG51F1/EU1, RG51F3/EU1
Rated Voltage	3.0V(Dry batteries R03/LR03 × 2)
Signal Receiving Range	8m
Environment	62℉~ 86℉

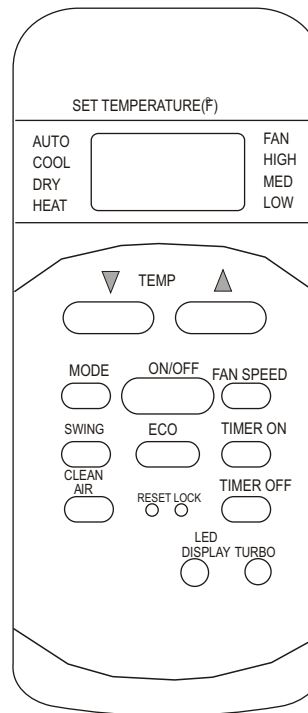

Model: RG51F3/EU1  
 RG51F/EU1(This model does not have clean air button)

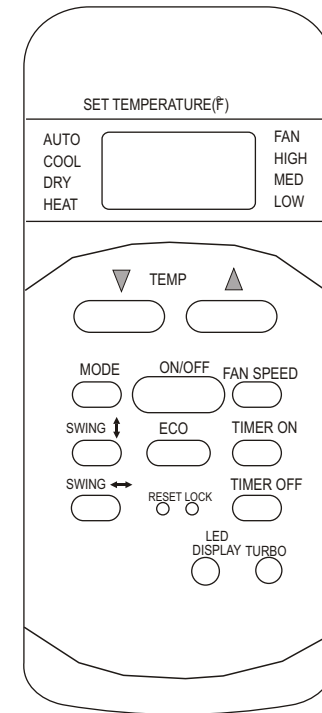

Model : RG51F1/EU1

## Operation of buttons

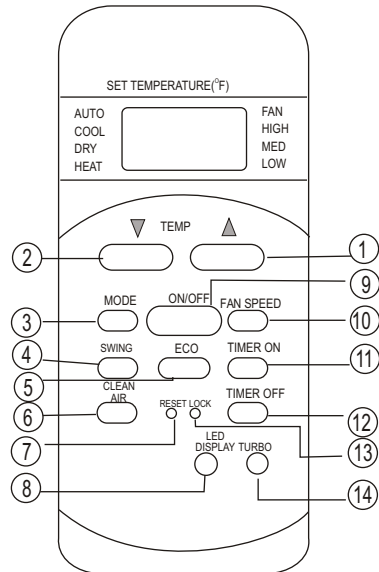

Model: RG51F3/EU1

RG51F/EU1(This model does not have clean air button)

### 1 TEMP UP Button

Push this button to increase the indoor temperature setting in 1°F increments to 86°F.

### 2 TEMP DOWN Button

Push this button to decrease the indoor temperature setting in 1°F increments to 62°F.

**NOTE:** Temperature control is not available in Fan mode.

**NOTE:** Press and hold **UP** and **DOWN** buttons together for 3 seconds will alternate the temperature display between the °C & °F scale.

### 3 MODE Button

Press this button to modify the air conditioner mode in a sequence of the following:



**NOTE:** Please do not select HEAT mode if the machine you purchased is cooling only type. Heat mode is not supported by the cooling only appliance.

### 4 SWING/SWING ↓ Button

Used to stop or start horizontal louver movement or set the desired up/down air flow direction. The louver changes 6 degree in angle for each press. If keep pushing more than 2 seconds, the louver will swing up and down automatically.

### 5 ECO Button:

Used to enter the energy efficient mode. Under cooling mode, press this button, the remote controller will adjust the temperature automatically to 75°F, fan speed of Auto to save energy (but only if the set temperature is less than 75°F). If the set temperature is between 75°F and 86°F, press the ECO button, the fan speed will change to Auto, the set temperature will remain unchanged.

#### **NOTE:**

- Pressing the TURBO and SLEEP button, modifying the mode or adjusting the set temperature to less than 75°F will stop ECO operation.

3

## Operation of buttons

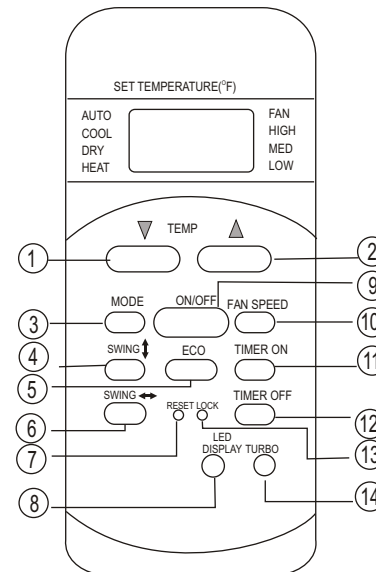

Model: RG51F1/EU1

- Under ECO operation, the set temperature should be 75°F or more. It may result in insufficient cooling. If you feel uncomfortable, just press the ECO button again to stop it.

### 6 CLEAN AIR Button (applicable to RG51F3)

Disable/Active clean air function. When the clean air function is initiated, the Ionizer/Plasma Dust Collector (depending on models) is energized and will help to remove pollen and impurities from the air.

### Swing ↔ Button (applicable to RG51F1)

Used to stop or start vertical louver movement and set the desired left/right air flow direction. The vertical louver changes 6 degree in angle for each press.

### 7 RESET Button

Once the recessed RESET button is pressed, all of the current settings will be cancelled and the controller will return to the initial settings.

### 8 LED Button

Disable/Active indoor screen Display. When pushing the button, the indoor screen display is cleared, press it again to light the display.

### 9 ON/OFF Button

Operation starts when this button is pressed and stops when the button is pressed again.

### 10 FAN SPEED Button

Used to select the fan speed in four steps:

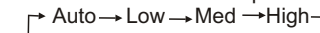

### 11 TIMER ON Button

Press this button to initiate the auto-on time sequence. Each press will increase the auto-timed setting in 30 minutes increments. When the setting time displays 10.0, each press will increase the auto-timed setting 60 minutes increments. To cancel the auto-timed program, simply adjust the auto-on time to 0.0.

4

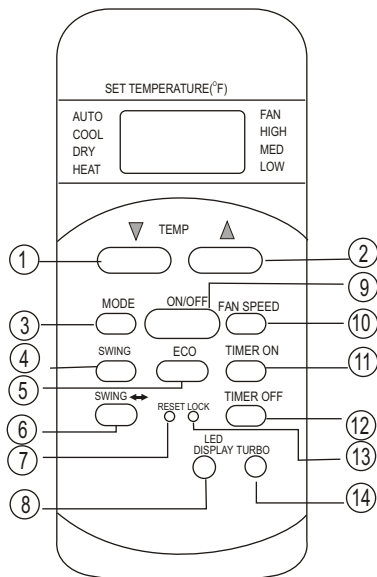

RG51F1/E

**12 TIMER OFF Button**  
 Press this button to initiate the auto-off time sequence. Each press will increase the auto-timed setting in 30 minutes increments. When the setting time displays 10.0, each press will increase the auto-timed setting 60 minutes increments. To cancel the auto-timed program, simply adjust the auto-off time to 0.0

**13 LOCK Button**  
 Press this recessed button to lock all current settings, and the remote controller will not accept any operation except that of the LOCK. Use the LOCK mode when you want to prevent settings from being changed accidentally. Press the LOCK button again to cancel the LOCK function. A lock symbol  will appear on the remote controller display when the lock function is activated.

**14 TURBO Button**  
 Active/Disable Turbo function. Turbo function enables the unit to reach the preset temperature at cooling or heating operation in the shortest time (if the indoor unit does not support this function, there is no corresponding operation happened when pressing this button.)

**NOTE:**

- Buttons design is based on typical model and might be slightly different from the actual one you purchased, the actual shape shall prevail.
- All the functions described are accomplished by the unit. If the unit has no this feature, there is no corresponding operation happened when press the relative button on the remote controller.
- When there are wide differences between "Remote controller Illustration" and "USER'S MANUAL" on function description, the description of "USER'S MANUAL" shall prevail.

**Indicators on LCD**

Information are displayed when the remote controller is powered up.

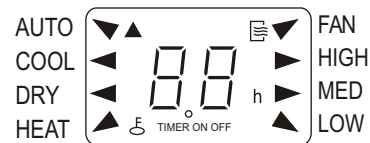

**Mode display**

AUTO ▼ COOL ◀ DRY ◀  
 HEAT ▲ FAN ▼

- ▲ Displayed when data transmitted.
-  Displayed when remote controller is ON.

TIMER ON Displayed when TIMER ON time is set.  
 TIMER OFF Displayed when TIMER OFF time is set.

Show set temperature or room temperature, or time under TIMER setting.

 Indicated all the current settings are locked

**Fan speed indication**

- ▶ HIGH High speed
- ▶ MED Medium speed
- ▲ LOW Low speed
- NO display Auto fan speed

**Note:**

All indicators shown in the figure are for the purpose of clear presentation. But during the actual operation only the relative functional signs are shown on the display window.

## How to use the buttons

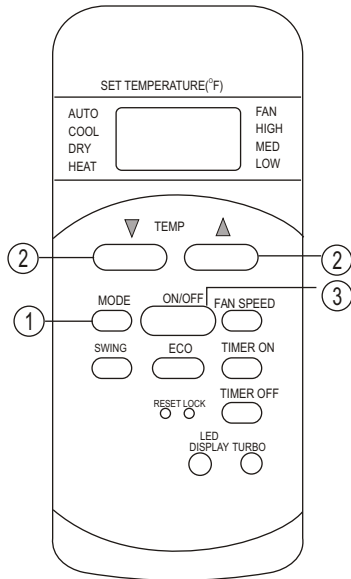

### Auto operation

Ensure the unit is plugged in and power is available. The OPERATION indicator on the display panel of the indoor unit starts flashing.

1. Press the **MODE** button to select Auto.
2. Press the **UP/DOWN** button to set the desired temperature. The temperature can be set within a range of 62°F~86°F in 1°F increments.
3. Press the **ON/OFF** button to start the air conditioner.

#### NOTE

1. In the Auto mode, the air conditioner can logically choose the mode of Cooling, Fan, and Heating by sensing the difference between the actual ambient room temperature and the setting temperature on the remote controller.
2. In the Auto mode, you can not switch the fan speed. It has already been automatically controlled.
3. If the Auto mode is not comfortable for you, the desired mode can be selected manually.

### Cooling /Heating/Fan operation

Ensure the unit is plugged in and power is available.

1. Press the **MODE** button to select COOL, HEAT (cooling & heating models only) or FAN mode.
2. Press the **UP/DOWN** buttons to set the desired temperature. The temperature can be set within a range of 62°F~86°F in 1°F increments.
3. Press the **FAN** button to select the fan speed in four steps- Auto, Low, Med, or High.
4. Press the **ON/OFF** button to start the air conditioner.

#### NOTE

In the FAN mode, the setting temperature is not displayed in the remote controller and you are not able to control the room temperature either. In this case, only step 1, 3 and 4 may be performed.

## How to use the buttons

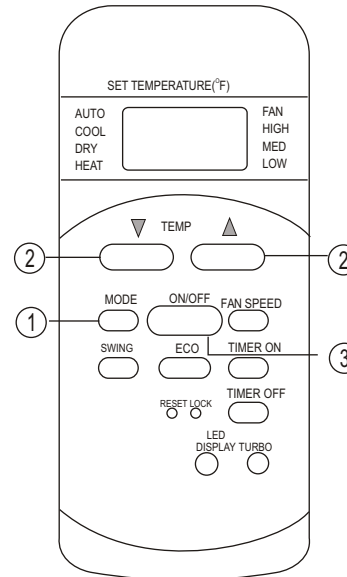

### Dehumidifying operation

Ensure the unit is plugged in and power is available. The OPERATION indicator on the display panel of the indoor unit starts flashing.

1. Press the **MODE** button to select DRY mode.
2. Press the **UP/DOWN** buttons to set the desired temperature. The temperature can be set within a range of 62°F~86°F in 1°F increments.
3. Press the **ON/OFF** button to start the air conditioner.

#### NOTE

In the Dehumidifying mode, you can not switch the fan speed. It has already been automatically controlled.

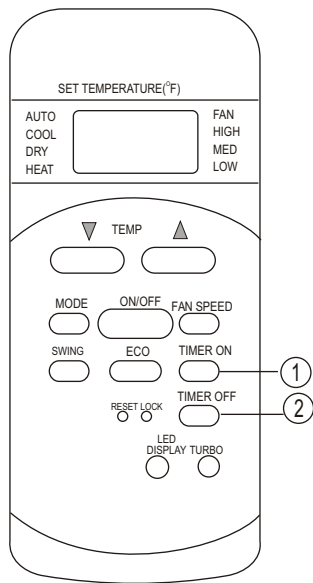

### Timer operation

Press the TIMER ON button can set the auto-on time of the unit. Press the TIMER OFF button can set the auto-off time of the unit.

#### To set the Auto-on time.

1. Press the TIMER ON button. The remote controller shows TIMER ON, the last Auto-on setting time and the signal "H" will be shown on the LCD display area. Now it is ready to reset the Auto-on time to START the operation.
2. Push the TIMER ON button again to set desired Auto-on time. Each time you press the button, the time increases by half an hour between 0 and 10 hours and by one hour between 10 and 24 hours.
3. After setting the TIMER ON, there will be a one second delay before the remote controller transmits the signal to the air conditioner. Then, after approximately another 2 seconds, the signal "h" will disappear and the set temperature will re-appear on the LCD display window.

#### To set the Auto-off time.

1. Press the TIMER OFF button. The remote controller shows TIMER OFF, the last Auto-off setting time and the signal "H" will be shown on the LCD display area. Now it is ready to reset the Auto-off time to stop the operation.
2. Push the TIMER OFF button again to set desired Auto-off time. Each time you press the button, the time increases by half an hour between 0 and 10 hours and by one hour between 10 and 24 hours.
3. After setting the TIMER OFF, there will be a one second delay before the remote controller transmits the signal to the air conditioner. Then, after approximately another 2 seconds, the signal "H" will disappear and the set temperature will re-appear on the LCD display window.

#### CAUTION

- The effective operation time set by the remote controller for the timer function is limited to the following settings: 0.5, 1.0, 1.5, 2.0, 2.5, 3.0, 3.5, 4.0, 4.5, 5.0, 5.5, 6.0, 6.5, 7.0, 7.5, 8.0, 8.5, 9.0, 9.5, 10, 11, 12, 13, 14, 15, 16, 17, 18, 19, 20, 21, 22, 23 and 24.

#### Example of timer setting

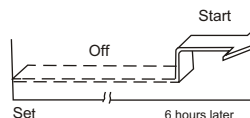
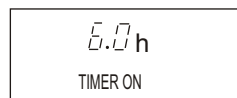

#### TIMER ON (Auto-on Operation)

The TIMER ON feature is useful when you want the unit to turn on automatically before you return home. The air conditioner will automatically start operating at the set time.

#### Example:

To start the air conditioner in 6 hours.

1. Press the TIMER ON button, the last setting of starting operation time and the signal "h" will show on the display area.
2. Press the TIMER ON button to display "6.0h" on the TIMER ON display of the remote controller.
3. Wait for 3 seconds and the digital display area will show the temperature again. The "TIMER ON" indicator remains on and this function is activated.

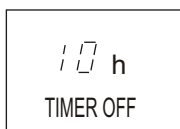

### TIMER OFF (Auto-off Operation)

The TIMER OFF feature is useful when you want the unit to turn off automatically after you go to bed. The air conditioner will stop automatically at the set time.

#### Example:

To stop the air conditioner in 10 hours.

1. Press the TIMER OFF button, the last setting of stopping operation time and the signal "h" will show on the display area.
2. Press the TIMER OFF button to display "10h" on the TIMER OFF display of the remote controller.
3. Wait for 3 seconds and the digital display area will show the temperature again. The "TIMER OFF" indicator remains on and this function is activated.

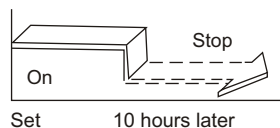

### COMBINED TIMER (Setting both ON and OFF timers simultaneously)

TIMER OFF → TIMER ON  
(On → Stop → Start operation)

This feature is useful when you want to stop the air conditioner after you go to bed, and start it again in the morning when you wake up or when you return home.

#### Example:

To stop the air conditioner 2 hours after setting and start it again 10 hours after setting.

1. Press the TIMER OFF button.
2. Press the TIMER OFF button again to display 2.0H on the TIMER OFF display.
3. Press the TIMER ON button.
4. Press the TIMER ON button again to display 10H on the TIMER ON display .
5. Wait for 3 seconds and the digital display area will show the temperature again. The "TIMER ON OFF" indicator remains on and this function is activated.

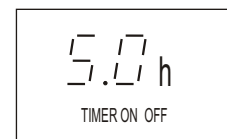
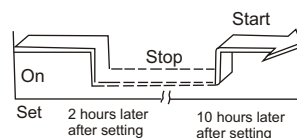

TIMER ON → TIMER OFF  
(Off → Start → Stop operation)

This feature is useful when you want to start the air conditioner before you wake up and stop it after you leave the house.

#### Example:

To start the air conditioner 2 hours after setting, and stop it 5 hours after setting.

1. Press the TIMER ON button.
2. Press the TIMER ON button again to display 2.0H on the TIMER ON display.
3. Press the TIMER OFF button.
4. Press the TIMER OFF button again to display 5.0H on the TIMER OFF display .
5. Wait for 3 seconds and the digital display area will show the temperature again. The "TIMER ON OFF" indicator remains on and this function is activated.

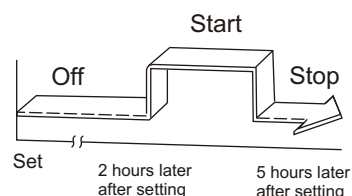

### Handling the remote controller

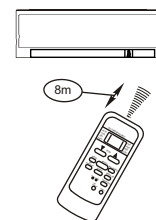

#### Location of the remote controller.

- Use the remote controller within a distance of 8 meters from the appliance, pointing it towards the receiver. Reception is confirmed by a beep.

#### CAUTIONS

- The air conditioner will not operate if curtains, doors or other materials block the signals from the remote controller to the indoor unit.
- Prevent any liquid from falling into the remote controller. Do not expose the remote controller to direct sunlight or heat.
- If the infrared signal receiver on the indoor unit is exposed to direct sunlight, the air conditioner may not function properly. Use curtains to prevent the sunlight from falling on the receiver.
- If other electrical appliances react to the remote controller, either move these appliances or consult your local dealer.
- Do not drop the remote controller. Handle with care.  
Do not place heavy objects on the remote controller, or step on it.

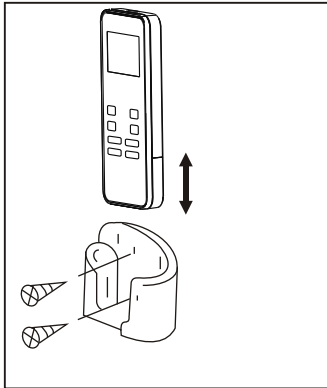

### Using the remote controller holder (optional)

- The remote controller can be attached to a wall or pillar by using a remote controller holder (not supplied, purchased separately).
- Before installing the remote controller, check that the air conditioner receives the signals properly.
- Install the remote controller with two screws.
- For installing or removing the remote controller, move it up or down in the holder.

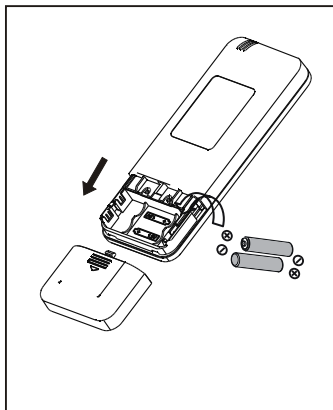

### Replacing batteries

The following cases signify exhausted batteries. Replace old batteries with new ones.

- Receiving beep is not emitted when a signal is transmitted.
- Indicator fades away.

The remote controller is powered by two dry batteries (R03/LR03X2) housed in the back rear part and protected by a cover.

- (1) Remove the cover in the rear part of the remote controller.
- (2) Remove the old batteries and insert the new batteries, placing the (+) and (-) ends correctly.
- (3) Install the cover back on.

**NOTE:** When the batteries are removed, the remote controller erases all programming. After inserting new batteries, the remote controller must be reprogrammed.

### ⚠ CAUTIONS

- Do not mix old and new batteries or batteries of different types.
- Do not leave the batteries in the remote controller if they are not going to be used for 2 or 3 months.
- Do not dispose batteries as unsorted municipal waste. Collection of such waste separately for special treatment is necessary.

### NOTE:

The device could comply with the local national regulations.

- In Canada, it should comply with CAN ICES-3(B)/NMB-3(B).
- In USA, this device complies with part 15 of the FCC Rules. Operation is subject to the following two conditions:
  - (1) This device may not cause harmful interference, and
  - (2) this device must accept any interference received, including interference that may cause undesired operation.

This equipment has been tested and found to comply with the limits for a Class B digital device, pursuant to part 15 of the FCC Rules. These limits are designed to provide reasonable protection against harmful interference in a residential installation. This equipment generates, uses and can radiate radio frequency energy and, if not installed and used in accordance with the instructions, may cause harmful interference to radio communications. However, there is no guarantee that interference will not occur in a particular installation. If this equipment does cause harmful interference to radio or television reception, which can be determined by turning the equipment off and on, the user is encouraged to try to correct the interference by one or more of the following measures:

- Reorient or relocate the receiving antenna.
- Increase the separation between the equipment and receiver.
- Connect the equipment into an outlet on a circuit different from that to which the receiver is connected.
- Consult the dealer or an experienced radio/TV technician for help.
- Changes or modifications not approved by the party responsible for compliance could void user's authority to operate the equipment.